

Halbzeuge und Wickelrohre / Semi finished products and spiral pipes

Materialübersicht

PE - Polyethylen. Temperaturbeständig von -40 °C bis 80 °C, gute Säuren- und Laugenbeständigkeit, geringes Gewicht, in schwarz sehr gut witterungsbeständig, trinkwasser- und lebensmittelgeeignet.

PE-el - elektisch ableitfähiges Polyethylen. Für die spannenden Momente.

PP - Polypropylen. Temperaturbeständig von -10 °C bis 100 °C, chemisch ähnliche Eigenschaften im Vergleich zu PE, höhere Steifigkeit.

PPs - schwerentflammbares Polypropylen. Nicht zu verwechseln mit PPS.

PPs-el - schwerentflammbares Polypropylen, das zusätzlich elektisch ableitfähig ist.

PVDF - Polyvinylidenfluorid.
Wenn PE und PP nicht mehr ausreichen. Hochreiner Werkstoff, der auch für etwas höhere Temperaturen geeignet ist. -40 °C bis 140 °C sind möglich. Von Natur aus schwer entflammbar. Für die meisten hochkonzentrierten Säuren einsetzbar.





PVDF-el elektisch ableitfähiges PVDF.

ECTFE - Ethylenchlorotrifluorethylen. Verbindet die positiven Eigenschaften von PVDF mit einer noch besseren chemischen Beständigkeit gegenüber hochkonzentrierten Laugen und ist von -70 bis 140°C im Einsatz.





FEP - Perfluorethylenpropylen.
Wenn es etwas mehr sein darf. Temperaturbereich -190°C bis 200°C. Hauptsächlich als Auskleidungswerkstoff in Verbund mit einem Trägermaterial verwendet. Hervorragende chemische Beständigkeit auch bei höheren Temperaturen.

PFA - Perfluoralkoxy-Polymere.
Temperaturbereich -190 °C bis 260 °C. Die Weiterentwicklung von Teflon. Schweißbar.







PE

	Seite
Platten extrudiert / Sheets extruded	
 PE 100 Platten430	
PE 100-RC Platten430	
PE Platten blau430	
PE Platten natur 431	
PE-el Platten 431	
Platten kaschiert / Sheets fabric backed	
 PE Platten 431	
Platten gepresst / Sheets pressed	
 PE 100 Platten432	
PE Platten natur432	
PE-el Platten432	
Rundstäbe / Round bar	
 PE 100-RC Rundstäbe433	
PE-el Rundstäbe433	
Schweißdrähte / Welding rod	
 Spulen 3 kg434	
Spulen 10 kg434	







PP

	Seite
Platten extrudiert / Sheets extruded	
 PP Platten434	
PP Platten natur435	
PP Platten weiß435	
PPs Platten435	
PPs-el Platten436	
Platten kaschiert / Sheets fabric backed	
 PP Platten436	
Platten gepresst / Sheets pressed	
 PP Platten436	
PPs Platten437	
PP Platten natur437	
Rundstäbe / Round bar	
 PP Rundstäbe438	
PPs-el Rundstäbe438	
Schweißdrähte / Welding rod	
 Spulen 3 kg439	
Spulen 10 kg439	

PVDF







	Seite
Platten extrudiert / Sheets extruded	
 PVDF Platten440	
Platten kaschiert und HV Liner/ Sheets fabric backed and HV Liner	
 PVDF Platten440	
PVDF SK+ Platten440	
 PVDF FLEX Platten..... 441	
PVDF FLEX Platten..... 441	
HV Liner 441	
Platten gepresst / Sheets pressed	
 PVDF Platten442	
Rundstäbe / Round bar	
 PVDF Rundstäbe442	
PVDF Hohlstäbe442	
Schweißdrähte / Welding rod	
 Spule 2 kg443	
 Rolle 1 kg443	

PVDF-el

	Seite
Platten / Rohre extrudiert / Sheets / Pipes extruded	
 PVDF-el Platten443	
PVDF-el Rohre444	
Platten kaschiert und HV Liner / Sheets fabric backed and HV Liner	
 PVDF-el SK+Platten444	
 PVDF-el-Rohre (HV Liner)444	
Platten gepresst / Sheets pressed	
 PVDF-el Platten445	
Rundstäbe / Round bar	
 PVDF-el Rundstäbe445	
Schweißdrähte / Welding rod	
 Spule 2 kg445	

NEU







ECTFE

	Seite
 Platten extrudiert / <i>Sheets extruded</i>	
ECTFE Platten	446
 Platten kaschiert / <i>Sheets fabric backed</i>	
ECTFE Platten	446
ECTFE Platten	447
 ECTFE Rohre kaschiert.....	447
 Platten gepresst / <i>Sheets pressed</i>	
ECTFE Platten	447
 Rundstäbe / <i>Round bar</i>	
ECTFE Rundstäbe	448
 Schweißdrähte / <i>Welding rod</i>	
Spule 2 kg	448

Reinigungsdraht

	Seite
 Reinigungsdraht / <i>Purging rod</i>	
Spule 2 kg	454



PFA

	Seite
 Platten extrudiert / <i>Sheets extruded</i>	
PFA Platten	449
PFA HP Platten	450
 Platten kaschiert gerollt / <i>Sheets fabric-rolled</i>	
PFA Platten GGS	450
PFA HP Platten GGS	451
 Rundstäbe / <i>Round bar</i>	
PFA Rundstäbe	451
PFA HP Rundstäbe	451
 Rohre / <i>Pipes</i>	
PFA Rohre	452
 PFA Abdeckkappe / <i>PFA Covering Cap</i>	
.....	452
 Schweißdrähte / <i>Welding rod</i>	
PFA-Rolle 1 kg	453

Filament für 3D Drucker

	Seite
 Reinigungsdraht / <i>Purging rod</i>	
Spule 1 kg	455

FEP

	Seite
 Platten kaschiert gerollt / <i>Sheets rolled</i>	
FEP Platten	453
 Rohre / <i>Pipes</i>	
FEP Rohre	453
FEP Rohre GGS	454
 Schweißdrähte / <i>Welding rod</i>	
FEP-Rolle 1 kg	454

Wickelrohr

	Seite
 Wickelrohr / <i>Spiral pipe</i>	
Lieferübersicht	456

PE 100 Platten extrudiert / PE 100 extruded sheets

schwarz,
mit beidseitiger Schutzfolie auf Anfrage

DIBt
zugelassen
für s = 5 - 30 mm

Artikelgruppe **PE 100** 25 600...

	Dicke [mm]
	2
	3
	4
	5
	6
	8
	10
	12
	15
	20
	25
	30

2000 x 1000		3000 x 1500		4000 x 2000	
Art.-Nr.	kg/Stk.	Art.-Nr.	kg/Stk.	Art.-Nr.	kg/Stk.
2010 02	3,85				
2010 03	5,77	3015 03	13,00	4020 03	23,10
2010 04	7,70	3015 04	17,30	4020 04	30,80
2010 05	9,62	3015 05	21,70	4020 05	38,50
2010 06	11,50	3015 06	26,00	4020 06	46,20
2010 08	15,40	3015 08	34,60	4020 08	61,60
2010 10	19,20	3015 10	43,30	4020 10	77,00
2010 12	23,10	3015 12	52,00	4020 12	92,40
2010 15	28,90	3015 15	65,00	4020 15	115,00
2010 20	38,50	3015 20	86,60	4020 20	154,00
2010 25	48,10	3015 25	108,00	4020 25	192,00
2010 30	57,70	3015 30	130,00	4020 30	231,00

PE 100-RC Platten extrudiert / PE-100 RC extruded sheets

schwarz

DIBt
zugelassen
für s = 5 - 40 mm

Artikelgruppe **PE 100-RC** 70 600...

	Dicke [mm]
	3
	4
	5
	6
	8
	10
	12
	15
	20
	25
	30
	35
	40
	45
	50

2000 x 1000		3000 x 1500		4000 x 2000	
Art.-Nr.	kg/Stk.	Art.-Nr.	kg/Stk.	Art.-Nr.	kg/Stk.
		3015 03	13,00		
		3015 04	17,30		
		3015 05	21,70		
		3015 06	26,00		
		3015 08	34,60		
		3015 10	43,30		
		3015 12	52,00	4020 12	92,40
		3015 15	65,00	4020 15	115,00
		3015 20	86,60	4020 20	154,00
		3015 25	108,00	4020 25	192,00
		3015 30	130,00	4020 30	231,00
2010 35	67,40	3015 35	152,00	4020 35	269,00
2010 40	77,00	3015 40	173,00	4020 40	308,00
		3015 45	195,00		
		3015 50	217,00		

PE Platten extrudiert / PE extruded sheets

blau, RAL 5012

DVGW

Artikelgruppe **PE blau** 86 600...

	Dicke [mm]
	5
	8
	10
	12
	15
	20
	30

4000 x 2000	
Art.-Nr.	kg/Stk.
4020 05	38,10
4020 08	60,90
4020 10	76,10
4020 12	91,40
4020 15	114,00
4020 20	152,00
4020 30	228,00

PE Platten extrudiert / PE extruded sheets

natur

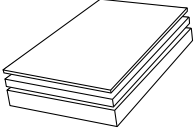
	Dicke [mm]
	3
	4
	5
	6
	8
	10
	12
	15
	20
	25

Artikelgruppe **PE natur** 29 600...

2000 x 1000		3000 x 1500	
Art.-Nr.	kg/Stk.	Art.-Nr.	kg/Stk.
2010 03	5,71	3015 03	12,90
2010 04	7,62	3015 04	17,10
2010 05	9,52	3015 05	21,40
2010 06	11,40	3015 06	25,70
2010 08	15,20	3015 08	34,30
2010 10	19,00	3015 10	42,90
		3015 12	51,40
		3015 15	64,30
		3015 20	85,70
		3015 25	107,50

PE-el Platten extrudiert / PE-el extruded sheets

schwarz,
mit einseitiger Schutzfolie

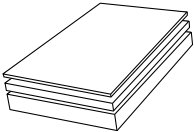
	Dicke [mm]
	4
	5
	6
	8
	10
	12
	15
	20

Artikelgruppe **PE-el** 28 600...

2000 x 1000		3000 x 1500	
Art.-Nr.	kg/Stk.	Art.-Nr.	kg/Stk.
2010 04	8,26		
2010 05	10,30	3015 05	23,20
2010 06	12,40		
2010 08	16,50	3015 08	37,10
2010 10	20,60	3015 10	46,40
2010 12	24,80	3015 12	55,70
2010 15	31,00	3015 15	69,60
2010 20	41,30		

PE 100 Platten kaschiert / PE backend sheets

schwarz, Polyestergerewebe, mit einseitiger Schutzfolie

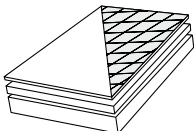
	Dicke [mm]
	5

Artikelgruppe **PE 100** 25 610...

3000 x 1500	
Art.-Nr.	kg/m ²
3015 05	5,11

PE 100 Platten gepresst / PE 100 pressed sheets

schwarz

Artikelgruppe **PE 100** 25 640...

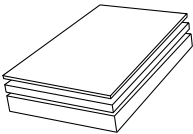
Dicke [mm]	
	10
	12
	15
	20
	25
	30
	40
	50
	60
	70
	80
	90
	100
	110
	120

2000 x 1000		4000 x 2000	
Art.-Nr.	kg/Stk.	Art.-Nr.	kg/Stk.
2010 10	21,30		
2010 12	25,20		
2010 15	31,00	4020 15	124,00
2010 20	40,70	4020 20	162,00
2010 25	50,40	4020 25	201,00
2010 30	61,10	4020 30	243,00
2010 40	80,50	4020 40	320,00
2010 50	101,00	4020 50	401,00
2010 60	120,00	4020 60	479,00
2010 70	140,00		
2010 80	159,00		
2010 90	179,00		
2011 00	198,00		
2011 10	222,00		
2011 20	242,00		

PE Platten gepresst / PE pressed sheets

natur

Artikelgruppe **PE natur** 29 640...

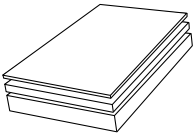
Dicke [mm]	
	10
	12
	15
	20
	25
	30
	40
	50
	60
	70
	80

2000 x 1000		4000 x 2000	
Art.-Nr.	kg/Stk.	Art.-Nr.	kg/Stk.
2010 10	21,10		
2010 12	25,00		
2010 15	30,70	4020 15	122,00
2010 20	40,30	4020 20	160,00
2010 25	49,90	4020 25	199,00
2010 30	60,50	4020 30	241,00
2010 40	79,70	4020 40	317,00
2010 50	99,80	4020 50	397,00
2010 60	119,00	4020 60	474,00
2010 70	138,00		
2010 80	157,00		

PE-el Platten gepresst / PE-el pressed sheets

schwarz

Artikelgruppe **PE-el** 28 640...

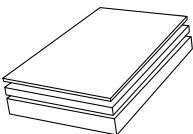
Dicke [mm]	
	25
	30
	40
	50
	60

2000 x 1000	
Art.-Nr.	kg/Stk.
2010 25	54,10
2010 30	65,60
2010 40	86,40
2010 50	108,00
2010 60	129,20

PE 100-RC Rundstäbe extrudiert / PE 100 extruded round bars

nach DIN 16980, schwarz

Artikelgruppe **PE 100** 70 800...

d [mm]
15
20
25
30
35
40
45
50
55
60
70
75
80
90
100
110
125
140
160
180
200
220
250
300
325
410
510
640

L = 1 m	
Art.-Nr.	kg/m
0015 10	0,18
0020 10	0,32
0025 10	0,50
0030 10	0,71
0035 10	0,96
0040 10	1,26
0045 10	1,60
0050 10	1,97
0055 10	2,38
0060 10	2,83
0070 10	3,84
0075 10	4,40
0080 10	5,03
0090 10	6,37
0100 10	7,88
0110 10	9,53
0125 10	12,30
0140 10	15,50
0160 10	20,20
0180 10	25,60
0200 10	31,70
0220 10	38,10
0250 10	49,10
0300 10	70,40
0325 10	82,93
0410 10	131,00
0510 10	208,00
0640 10	320,00

PE-el Rundstäbe extrudiert / PE-el extruded round bars

nach DIN 16980, schwarz

Artikelgruppe **PE-el** 28 800...

d [mm]
50
60
80
160

L = 1 m	
Art.-Nr.	kg/m
0050 10	2,05
0060 10	2,95
0080 10	5,24
0160 10	21,00

PE Schweißdraht / PE welding rod

Spule mit 3 kg

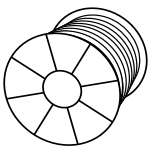
d [mm]	
	3
	4
	5

PE 100 schwarz	PE 100-RC schwarz	PE-el schwarz	PE gelb	PE natur	PE achatgrau	PE blau
Art.-Nr. 25 410 ...	Art.-Nr. 70 410 ...	Art.-Nr. 28 410 ...	Art.-Nr. 21 410 ...	Art.-Nr. 29 410 ...	Art.-Nr. 56 410 ...	Art.-Nr. 86 410 ...
0000 30	0000 30	0000 30	0000 30	0000 30	0000 30	0000 30
0000 40	0000 40	0000 40	0000 40	0000 40	0000 40	0000 40
0000 50	0000 50					

PE Schweißdraht / PE welding rod

Spule mit 10 kg

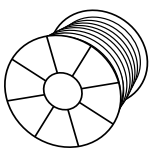
d [mm]	
	3
	4
	5

PE 100 schwarz
Art.-Nr. 25 410 ...
0100 30
0100 40
0100 50

PP Platten extrudiert / PP extruded sheets

grau, mit einseitiger Schutzfolie

Artikelgruppe **PP-H** 12 600...

Artikelgruppe **PP-R** 11 600...

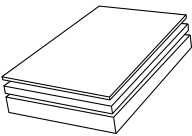
Dicke [mm]	
	1
	2
	3
	4
	5
	6
	8
	10
	12
	15
	20
	25
	30
35	
40	
50	

2000 x 1000		3000 x 1500		4000 x 2000	
Art.-Nr.	kg/Stk.	Art.-Nr.	kg/Stk.	Art.-Nr.	kg/Stk.
2010 01	1,82				
2010 02	3,65				
2010 03	5,47	3015 03	12,30	4020 03	21,90
2010 04	7,30	3015 04	16,40	4020 04	29,20
2010 05	9,12	3015 05	20,50	4020 05	36,50
2010 06	10,90	3015 06	24,60	4020 06	43,80
2010 08	14,60	3015 08	32,80	4020 08	58,40
2010 10	18,20	3015 10	41,10	4020 10	73,00
2010 12	21,90	3015 12	49,30	4020 12	87,60
2010 15	27,40	3015 15	61,60	4020 15	109,00
2010 20	36,50	3015 20	82,10	4020 20	146,00
2010 25	45,60	3015 25	103,00	4020 25	182,50
2010 30	54,70	3015 30	123,00	4020 30	219,00
2010 35	63,80	3015 35	144,00	4020 35	255,00
2010 40	73,00	3015 40	164,00	4020 40	292,00
		3015 50	205,00	4020 50	365,00

PP Platten extrudiert / PP extruded sheets

natur, mit beidseitiger Schutzfolie

	Dicke [mm]
	2
	3
	4
	5
	6
	8
	10
	12
	15
	20
	25

Artikelgruppe **PP natur** 16 600...

2000 x 1000		3000 x 1500	
Art.-Nr.	kg/Stk.	Art.-Nr.	kg/Stk.
2010 02	3,65		
2010 03	5,47	3015 03	12,30
2010 04	7,30	3015 04	16,40
2010 05	9,12	3015 05	20,50
2010 06	10,90	3015 06	24,60
		3015 08	32,80
		3015 10	41,10
		3015 12	49,30
		3015 15	61,60
		3015 20	82,10
		3015 25	103,00

PP Platten extrudiert / PP extruded sheets

weiß, mit beidseitiger Schutzfolie

	Dicke [mm]
	6
	10
	15
	20

Artikelgruppe **PP weiß** 15 600...

3000 x 1500	
Art.-Nr.	kg/Stk.
3015 06	24,60
3015 10	41,10
3015 15	61,60
3015 20	82,10

PPs Platten extrudiert / PPs extruded sheets

grau, mit einseitiger Schutzfolie

	Dicke [mm]
	3
	4
	5
	6
	8
	10
	12
	15
	20

Artikelgruppe **PPs grau** 17 600...

2000 x 1000		3000 x 1500	
Art.-Nr.	kg/Stk.	Art.-Nr.	kg/Stk.
2010 03	5,59	3015 03	12,60
2010 04	7,46	3015 04	16,80
2010 05	9,32	3015 05	21,00
2010 06	11,20	3015 06	25,20
2010 08	14,90	3015 08	33,60
2010 10	18,60	3015 10	42,00
		3015 12	50,30
		3015 15	62,90
		3015 20	83,90

PPs-el Platten extrudiert / PPs-el extruded sheets

schwarz, mit einseitiger Schutzfolie

Artikelgruppe **PPs-el** 19 600...

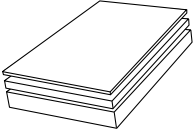
Dicke [mm]	
	3
	4
	5
	6
	8
	10
	12
	15
	20

2000 x 1000	
Art.-Nr.	kg/Stk.
2010 03	6,80
2010 04	9,06
2010 05	11,30
2010 06	13,60
2010 08	18,10
2010 10	22,70
2010 12	27,20
2010 15	34,00
2010 20	45,30

3000 x 1500	
Art.-Nr.	kg/Stk.
3015 04	21,27
3015 05	26,59
3015 06	31,91
3015 08	42,54
3015 10	53,18
3015 12	63,82
3015 15	79,77

PP Platten kaschiert / PP backend sheets

grau, Polyestergewebe, mit einseitiger Schutzfolie

Artikelgruppe **PP-H**

Platte: 12 610...

Artikelgruppe **PP-H**

Rolle: 12 615...

Artikelgruppe **PP-R¹⁾**

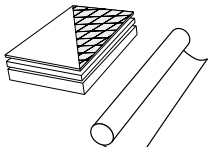
Dicke [mm]	
	3
	4
	5
	6

Rolle	
25000 x 1000	
Art.-Nr.	kg/m ²
2510 03	2,95
2510 04	3,94

Platte	
2000 x 1000	
Art.-Nr.	kg/m ²
2010 03	2,95
2010 04	3,94
2010 05	4,92
2010 06	5,90

Rolle	
25000 x 1500	
Art.-Nr.	kg/m ²
2515 03	2,95
2515 04	3,94

Platte	
3000 x 1500	
Art.-Nr.	kg/m ²
3015 03	2,95
3015 04	3,94
3015 05	4,92
3015 06	5,90

1) In PP-R: Platte 3000 x 1500, kaschiert, grau, Glasgewebe, Art.-Nr. 11620 3015 05, Gewicht 4,93 kg/m²

PP Platten gepresst / PP pressed sheets

grau

Artikelgruppe **PP-H** 12 640...

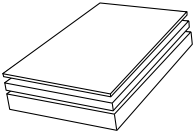
Dicke [mm]	
	10
	12
	15
	20
	25
	30
	40
	50
	60

2000 x 1000	
Art.-Nr.	kg/Stk.
2010 10	20,20
2010 12	23,90
2010 15	29,40
2010 20	38,60
2010 25	47,80
2010 30	57,90
2010 40	76,30
2010 50	95,60
2010 60	114,00

4000 x 2000	
Art.-Nr.	kg/Stk.
4020 15	117,10
4020 20	153,70
4020 25	190,30
4020 30	230,50
4020 40	303,70
4020 50	380,60
4020 60	454,00

PP Platten gepresst / PP pressed sheets

grau

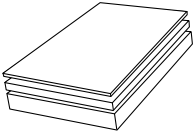
	Dicke [mm]
	70
	80
	90
	100
	120

Artikelgruppe **PP-R** 11 640...

2000 x 1000	
Art.-Nr.	kg/Stk.
2010 70	132,00
2010 80	151,00
2010 90	169,00
2011 00	188,00
2011 20	230,00

PPs Platten gepresst / PPs pressed sheets

grau

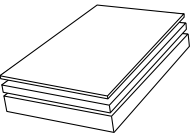
	Dicke [mm]
	25
	30
	40

Artikelgruppe **PPs** 17 640...

2000 x 1000	
Art.-Nr.	kg/Stk.
2010 25	48,90
2010 30	59,20
2010 40	78,00

PP Platten gepresst / PP pressed sheets

natur

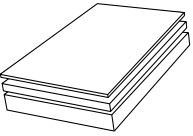
	Dicke [mm]
	10
	12
	15
	20
	25
	30
	40
	50
	60

Artikelgruppe **PP-natur** 16 640...

2000 x 1000		4000 x 2000	
Art.-Nr.	kg/Stk.	Art.-Nr.	kg/Stk.
2010 10	20,20		
2010 12	23,90		
2010 15	29,40	4020 15	117,10
2010 20	38,60	4020 20	153,70
2010 25	47,80	4020 25	190,30
2010 30	57,90	4020 30	230,50
2010 40	76,30	4020 40	303,70
2010 50	95,60	4020 50	380,60
2010 60	114,00	4020 60	454,00

PP Rundstäbe extrudiert / PP extruded round bars

nach DIN 16980, grau

Artikelgruppe **PP-R** 11 800...

	d [mm]
	15
	20
	25
	30
	35
	40
	45
	50
	55
	60
	70
	75
	80
	90
	100
	110
	125
	140
	160
	180
	200
	220
	250
	300
	325
	410
	510
	640

L = 1 m	
Art.-Nr.	kg/m
0015 10	0,17
0020 10	0,30
0025 10	0,47
0030 10	0,67
0035 10	0,91
0040 10	1,19
0045 10	1,51
0050 10	1,87
0055 10	2,25
0060 10	2,69
0070 10	3,64
0075 10	4,17
0080 10	4,77
0090 10	6,04
0100 10	7,47
0110 10	9,04
0125 10	11,70
0140 10	14,60
0160 10	19,20
0180 10	24,30
0200 10	30,00
0220 10	36,20
0250 10	46,50
0300 10	66,80
0325 10	78,62
0410 10	125,00
0510 10	193,00
0640 10	303,00

PPs-el Rundstäbe extrudiert / PPs-el extruded round bars

nach DIN 16980, schwarz

Artikelgruppe **PPs-el** 19 800...

	d [mm]
	20
	65
	80
	100

L = 1 m	
Art.-Nr.	kg/m
0020 10	0,37
0065 10	3,91
0080 10	5,93
0100 10	8,20

PP Schweißdraht / PP welding rod

Spule mit 3 kg

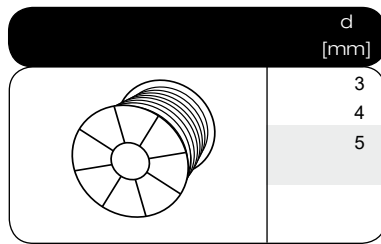

PP-H grau	PP-R grau	PP-B grau	PP natur	PP weiß	PPs grau	PPs-el schwarz
Art.-Nr. 12 410 ...	Art.-Nr. 11 410 ...	Art.-Nr. 10 410 ...	Art.-Nr. 16 410 ...	Art.-Nr. 15 410 ...	Art.-Nr. 17 410 ...	Art.-Nr. 19 410 ...
0000 30 0000 40 0000 50	0000 30 0000 40 0000 50	0000 30 0000 40	0000 30 0000 40	0000 30 0000 40	0000 30 0000 40	0000 30 0000 40

PP Schweißdraht / PP welding rod

Spule mit 10 kg

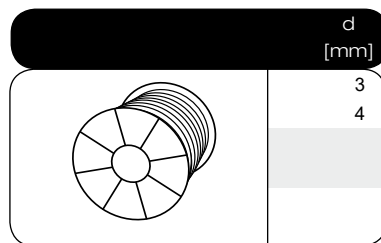

PP-H grau
Art.-Nr. 12 410 ...
0100 30 0100 40

PP Schweißdraht / PP welding rod

1 m Stange. Gebinde in 2 kg

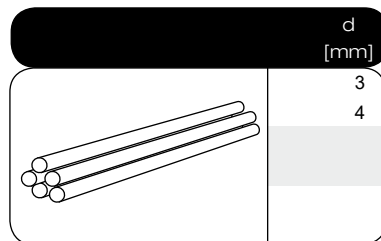

PP-H grau
Art.-Nr. auf Anfrage

PVDF FLEX Platten kaschiert / PVDF FLEX backend sheets

natur, **Polyestergewebe**, mit einseitiger Schutzfolie

NEU

Artikelgruppe **PVDF FLEX**

Platte: 79 610...

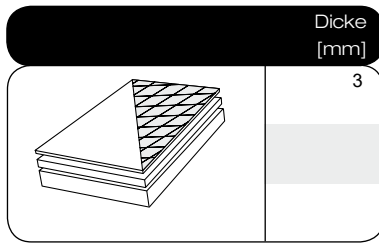

3000 x 1500	
Art.-Nr.	kg/m ²
3015 03	5,85

PVDF FLEX Platten SK+ kaschiert / PVDF FLEX SK+ backend sheets

natur, **Synthetikgestrick**, mit beidseitiger Schutzfolie

NEU

Artikelgruppe **PVDF**

Platte: 4K 670...

Artikelgruppe **PVDF**

Rolle: 4K 671...

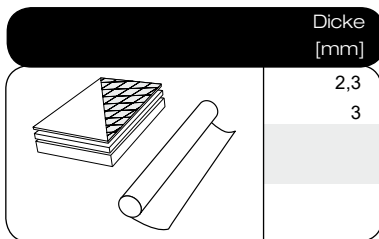

Rolle		Platte	
10000 x 1500		3000 x 1500	
Art.-Nr.	kg/m ²	Art.-Nr.	kg/m ²
1150 23	4,73	3015 23	4,73
1150 30	5,85	3015 30	5,85

PVDF-Rohre (HV Liner) / PVDF pipes (HV Liner)

natur, 5 m Stangen

NEU

Artikelgruppe **PVDF** 3H 705...

d	s	di
[mm]	[mm]	[mm]
20	1,9	16,2
25	1,9	21,2
32	2,4	27,2
40	2,4	35,2
50	3,0	44,0
63	3,0	57,0
75	3,0	69,0
90	2,8	84,4
110	3,0	104
125	3,0	119
140	3,0	134
160	3,0	154
200	3,0	194
250	3,0	244
315	4,0	307
355	4,0	347
400	5,0	390

Art.-Nr.	kg/m
0020 00	0,23
0025 00	0,29
0032 00	0,46
0040 00	0,57
0050 00	0,89
0063 00	1,11
0075 00	1,37
0090 00	1,65
0110 00	2,03
0125 00	2,31
0140 00	2,60
0160 00	2,98
0200 00	3,73
0250 00	4,68
0315 00	7,65
0350 00	8,88
0400 00	

PVDF Platten gepresst / PVDF pressed sheets

natur

Artikelgruppe **PVDF** 30 640...

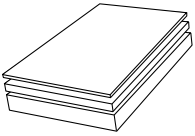
	Dicke [mm]	
	10	
	12	
	15	
	20	
	25	
	30	
	40	

2000 x 1000	
Art.-Nr.	kg/Stk.
2010 10	39,40
2010 12	46,60
2010 15	57,30
2010 20	75,29
2010 25	93,20
2010 30	112,90
2010 40	148,70

PVDF Rundstäbe extrudiert / PVDF extruded round bars

nach DIN 16980, natur, L=1 m

Artikelgruppe **PVDF** 30 800...

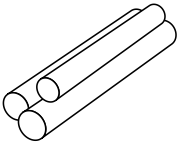
	d [mm]
	10
	15
	20
	25
	30
	35
	40
	45
	50
	60
	65
	75
	80
	90
	100
	110
	125
	140
	160
	180
200	
250	
300	
325	
340	

L = 1 m	
Art.-Nr.	kg/m
0010 10	0,15
0015 10	0,35
0020 10	0,59
0025 10	0,91
0030 10	1,30
0035 10	1,81
0040 10	2,31
0045 10	2,93
0050 10	3,61
0060 10	5,17
0065 10	6,15
0075 10	8,21
0080 10	9,22
0090 10	11,67
0100 10	14,42
0110 10	17,45
0125 10	22,35
0140 10	27,40
0160 10	36,00
0180 10	46,00
0200 10	57,65
0250 10	90,08
0300 10	129,40
0325 10	152,00
0340 10	166,40

PVDF Hohlstäbe extrudiert / PVDF extruded tubes

natur, L=1 m

Artikelgruppe **PVDF** 30 820...

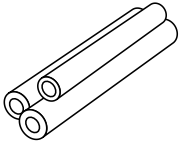
	d [mm]
	25/10
	30/15
	45/30

L = 1 m	
Art.-Nr.	kg/m
2510 10	0,75
3015 10	0,98
4530 10	1,71

PVDF Schweißdraht / PVDF welding rod

Spule mit 2 kg, natur

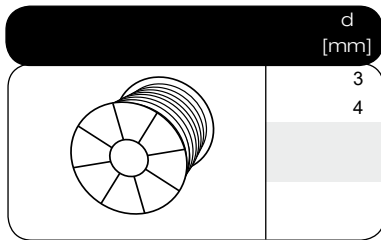

PVDF	PVDF FLEX
Art.-Nr. 30 410 ...	Art.-Nr. 79 410 ...
0000 30 0000 40	0000 30

PVDF Schweißdraht / PVDF welding rod

Rolle 1 kg, natur und orange

NEU

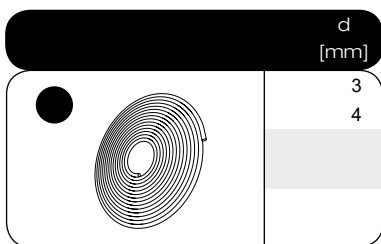

PVDF orange	PVDF natur
Art.-Nr. 32 410...	Art.-Nr. 32 410...
1100 31 1100 41	1100 30 1100 40

PVDF-el Platten extrudiert / PVDF-el extruded sheets

schwarz, mit beidseitiger Schutzfolie

NEU

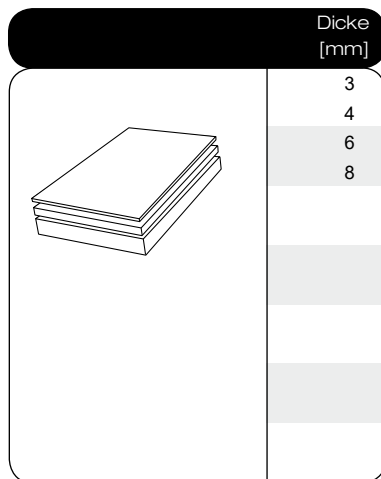

Artikelgruppe **PVDF-el** 4L 600...

3000 x 1500	
Art.-Nr.	kg/Stk.
3015 03	24,80
3015 04	33,20
3015 06	48,90
3015 08	65,60

**PVDF-el Platten SK+ kaschiert /
PVDF-el SK+ backend sheets**
schwarz, **Synthetikgestrick**, mit beidseitiger Schutzfolie

NEU

Artikelgruppe **PVDF-el** 4L 670...

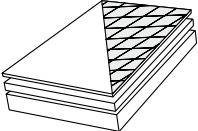
	Dicke [mm]
	4

3000 x 1500	
Art.-Nr.	kg/m ²
3015 03	5,85
3015 04	7,45

PVDF-el-Rohre extrudiert / PVDF-el extruded pipes
schwarz, 5 m Stangen

NEU

Artikelgruppe **PVDF-el** 4L 725...

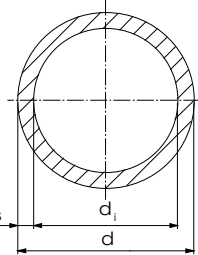
	d [mm]	s [mm]	di [mm]
		32	2,4
	40	2,4	35,2
	50	3,0	44,0
	63	3,0	57,0
	90	2,8	84,4
	110	3,0	104,0
	160	3,0	154,0
	200	3,0	194,0
	250	3,0	244,0

Art.-Nr.	kg/m
0032 00	0,42
0040 00	0,54
0050 00	0,83
0063 00	1,06
0090 00	1,58
0110 00	1,94
0160 00	2,85
0200 00	3,58
0250 00	4,49

PVDF-el-Rohre (HV Liner) / PVDF-el-pipes (HV Liner)
PVDF-el schwarz, 5 m Stangen

NEU

Artikelgruppe **PVDF-el** 4L 744...

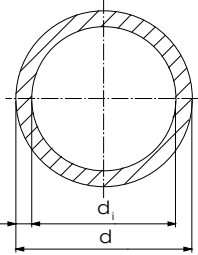
	d [mm]	s [mm]	di [mm]
		32	2,4
	40	2,4	35,2
	50	3,0	44,0
	63	3,0	57,0
	90	2,8	84,4
	110	3,0	104,0
	160	3,0	154,0
	200	3,0	194,0
	250	3,0	244,0

Art.-Nr.	kg/m
0032 00	0,46
0040 00	0,57
0050 00	0,89
0063 00	1,11
0090 00	1,65
0110 00	2,03
0160 00	2,98
0200 00	3,73
0250 00	4,68

PVDF-el Platten gepresst / PVDF-el pressed sheets

schwarz

NEU

Artikelgruppe **PVDF-el** 4L 640...

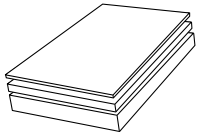
	Dicke [mm]
	10
	12
	15
	20
	25
	30
	40

2000 x 1000	
Art.-Nr.	kg/Stk.
2010 10	39,40
2010 10	46,60
2010 15	57,30
2010 20	75,29
2010 25	93,20
2010 30	112,90
2010 40	148,70

PVDF-el Rundstäbe extrudiert / PVDF-el extruded round bars

schwarz,

NEU

Artikelgruppe **PVDF-el** 4L 800...

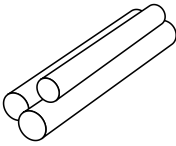
	d [mm]
	20
	25
	30
	40
	45
	50
	60
	70
	80
	90
	100
	125
	150
	200

L = 1 m	
Art.-Nr.	kg/m
0020 10	0,60
0025 10	0,95
0030 10	1,32
0040 10	2,35
0045 10	2,98
0050 10	3,66
0060 10	5,27
0070 10	7,14
0080 10	9,36
0090 10	11,84
0100 10	14,64
0125 10	22,61
0150 10	33,05
0180 10	47,55
0200 10	58,71

PVDF-el Schweißdraht / PVDF-el welding rod

Rolle 1 kg, schwarz

NEU

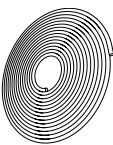
	d [mm]
	3
	4

PVDF-el
schwarz

Art.-Nr.
4L 410...
1100 30
1100 40

ECTFE Platten extrudiert / ECTFE extruded sheets

natur, mit beidseitiger Schutzfolie

Artikelgruppe **ECTFE** 40 600...

NEU

	Dicke [mm]
	2,3
	3
	4
	5
	6
	8
	10
	12
	15
	20

2000 x 1250	
Art.-Nr.	kg/Stk.
2012 04	16,80
2012 05	21,10
2012 06	25,30
2012 08	33,70
2012 10	42,10
2012 12	50,60
2012 15	63,20
2012 20	84,30

3000 x 1500	
Art.-Nr.	kg/Stk.
3015 23	17,50
3015 03	22,80

ECTFE Platten extrudiert / ECTFE extruded sheets

natur, mit beidseitiger Schutzfolie

Artikelgruppe **ECTFE** 40 600...

NEU

	Dicke [mm]
	3,18
	4,76
	6,35
	9,53
	12,7
	15,9
	19,1
	25,4

2440 x 1220	
Art.-Nr.	kg/Stk.
2412 31	16,00
2412 47	23,90
2412 63	31,90
2412 95	47,80
2412 12	63,90
2412 15	80,00
2412 19	96,10
2412 25	128,00

ECTFE Platten GGS kaschiert / ECTFE GGS backend sheets

natur, **Glasgestrick**, mit beidseitiger Schutzfolie

Artikelgruppe **ECTFE** Platte: 40 620...

Artikelgruppe **ECTFE** Rolle: 40 625...

	Dicke [mm]
	2,3
	3,0

Rolle	
15000 x 1500	
Art.-Nr.	kg/m ²
5150 23	4,65
5150 30	5,85

Platte	
3000 x 1500	
Art.-Nr.	kg/m ²
3015 23	4,65
3015 30	5,85

ECTFE Platten SK+ kaschiert /
ECTFE SK+ backend sheets
 natur, **Synthetikgestrick**, mit beidseitiger Schutzfolie

Artikelgruppe **ECTFE** Platte: 40 670...
 Artikelgruppe **ECTFE** Rolle: 40 671...

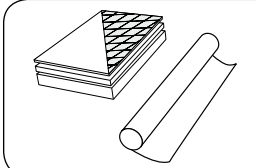
	Dicke [mm]
	2,3
	3,0

Rolle		Platte	
15000 x 1500		3000 x 1500	
Art.-Nr.	kg/m ²	Art.-Nr.	kg/m ²
5150 23	4,51	3015 23	4,51
5150 30	5,58	3015 30	5,58

ECTFE-Rohre SK+ kaschiert / ECTFE pipes SK+ fabric
 natur, **Synthetikgestrick**, 1 m und 5 m Stangen

NEU

Artikelgruppe **ECTFE** 40 743...

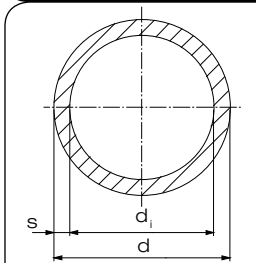
	d [mm]	s [mm]	di [mm]
	20	1,9	16,2
	25	1,9	21,2
	32	2,4	27,2
	40	2,4	35,2
	50	3,0	44,0
	63	3,0	57,0
	90	2,8	84,4
	110	3,0	104,0
	160	3,0	154,0

1 m		5 m	
Art.-Nr.	kg/m	Art.-Nr.	kg/m
1020 00	0,31	0020 00	0,31
1025 00	0,39	0025 00	0,39
1032 00	0,57	0032 00	0,57
1040 00	0,73	0040 00	0,73
1050 00	1,05	0050 00	1,05
1063 00	1,35	0063 00	1,35
1090 00	1,90	0090 00	1,90
1110 00	2,40	0110 00	2,40
1160 00	3,56	0160 00	3,56

ECTFE Platten gepresst / ECTFE pressed sheets
 natur

Artikelgruppe **ECTFE** 40 640...

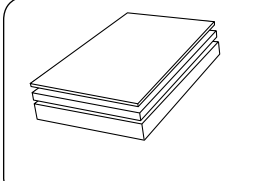
	Dicke [mm]
	10
	12
	15
	20
	25
	30

2000 x 1000	
Art.-Nr.	kg/Stk.
2010 10	37,20
2010 12	44,00
2010 15	54,10
2010 20	71,00
2010 25	88,00
2010 30	106,60

ECTFE Rundstäbe extrudiert / ECTFE extruded round bars

nach DIN 16980, natur, L = 1 m

Artikelgruppe **ECTFE** 40 800...

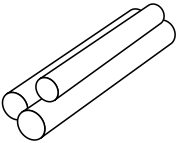
d [mm]	
	20
	25
	30
	35
	40
	45
	50
	60
	65
	80
	90
	100

L = 1 m	
Art.-Nr.	kg/m
0020 10	0,56
0025 10	0,86
0030 10	1,26
0035 10	1,68
0040 10	2,23
0045 10	2,76
0050 10	3,41
0060 10	4,87
0065 10	5,75
0080 10	8,70
0090 10	11,00
0100 10	13,60

ECTFE Schweißdraht / ECTFE welding rod

Spule mit 2 kg, natur

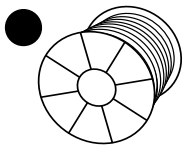
d [mm]	
	3
	3,5
	4

ECTFE

Art.-Nr.
40 410 ...
0000 30
0000 35
0000 40

PFA Platten gerollt / PFA sheets rolled

natur, extrudiert, mit beidseitiger Schutzfolie

NEU

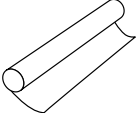
	Dicke [mm]
	1,5
	2,3

Artikelgruppe **PFA natur**

Rolle: 44 605...

10000 x 1250		20000 x 1250	
Art.-Nr.	kg/m ²	Art.-Nr.	kg/m ²
1125 23	5,04	2125 15	3,33

PFA Platten / PFA sheets

natur, extrudiert, mit beidseitiger Schutzfolie

NEU

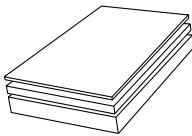
	Dicke [mm]
	2,3
	4
	6
	10
	12
	15
	20

Artikelgruppe **PFA natur** 44 600...

2000 x 900		2000 x 920		2000 x 1250	
Art.-Nr.	kg/Stk.	Art.-Nr.	kg/Stk.	Art.-Nr.	kg/Stk.
-	-	-	-	2012 23	12,60
-	-	-	-	2012 04	21,75
-	-	-	-	2012 06	32,50
-	-	2092 10	39,74	-	-
-	-	2092 12	47,66	-	-
2090 15	61,71	-	-	-	-
2090 20	81,06	-	-	-	-

PFA HP Platten / PFA HP sheets

natur, extrudiert, mit beidseitiger Schutzfolie

NEU

Artikelgruppe **PFA HP natur** 4H 600...

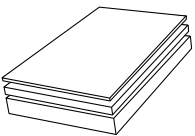
	Dicke [mm]
	4
	6
	10
	12
	15
	20

2000 x 900	
Art.-Nr.	kg/Stk.
-	-
-	-
-	-
-	-
2090 15	61,71
2090 20	81,06

2000 x 920	
Art.-Nr.	kg/Stk.
-	-
-	-
2092 10	39,74
2092 12	47,66
-	-
-	-

2000 x 1250	
Art.-Nr.	kg/Stk.
2012 04	21,75
2012 06	32,50
-	-
-	-
-	-
-	-

PFA Platten GGS kaschiert-gerollt / PFA GGS sheets fabric-rolled

natur, **Glasgestrick**, extrudiert, mit beidseitiger Schutzfolie

NEU

Artikelgruppe **PFA natur**

Rolle: 44 681...

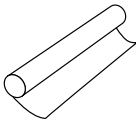
	Dicke [mm]
	2,3

10000 x 1250	
Art.-Nr.	kg/m ²
1125 23	5,91
-	-
-	-

PFA Platten GGS kaschiert / PFA GGS backend sheets

natur, **Glasgestrick**, extrudiert, mit beidseitiger Schutzfolie

NEU

Artikelgruppe **PFA natur** 44 680...

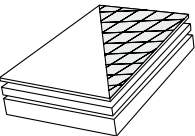
	Dicke [mm]
	0,8
	2,3

2000 x 1250	
Art.-Nr.	kg/Stk.
2012 08	3,76
2012 23	5,91
-	-
-	-

PFA HP Platten GGS kaschiert-gerollt / PFA HP sheets GGS fabric-rolled

natur, **Glasgestrick**, extrudiert, mit beidseitiger Schutzfolie

NEU

Artikelgruppe **PFA HP natur** Rolle: 4H 681...

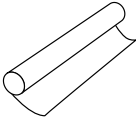
Dicke [mm]	
	2,3

10000 x 1250	
Art.-Nr.	kg/m ²
1125 23	5,91

PFA Rundstäbe extrudiert / PFA extruded round bars

natur, extrudiert, L = 1 m

NEU

Artikelgruppe **PFA natur** 44 800...

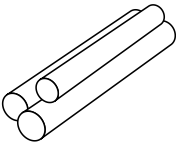
d [mm]	
	20
	25
	30
	40
	45
	50
	60
	70
	80
	100

L = 1 m	
Art.-Nr.	kg/m
0020 10	0,72
0025 10	1,12
0030 10	1,61
0040 10	2,84
0045 10	3,60
0050 10	4,43
0060 10	6,37
0070 10	8,63
0080 10	11,30
0100 10	17,68

PFA HP Rundstäbe extrudiert / PFA HP extruded round bars

natur, extrudiert, L = 1 m

NEU

Artikelgruppe **PFA HP natur** 4H 800...

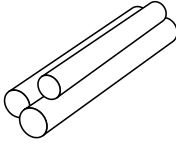
d [mm]	
	20
	25
	30
	40
	45
	50
	60
	80
	100

L = 1 m	
Art.-Nr.	kg/m
0020 10	0,72
0025 10	1,12
0030 10	1,61
0040 10	2,84
0045 10	3,60
0050 10	4,43
0060 10	6,37
0080 10	11,30
0100 10	17,68

PFA Rohre / PFA pipes

natur, extrudiert, L = 5 m

NEU

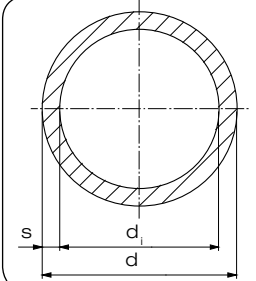
	d [mm]	s [mm]	di [mm]
	32	2,3	27,4
	50	2,3	45,4
	63	2,3	58,4
	90	2,3	85,4
	110	2,3	105,4

Artikelgruppe **PFA natur** 44 725...

L = 5 m	
Art.-Nr.	kg/m
0032 00	0,51
0050 00	0,82
0063 00	1,04
0090 00	1,51
0110 00	1,85

PFA Rohre GGS kaschiert / PFA pipes GGS fabric

natur, extrudiert, **Glasgestrick**, L = 1 m und 5 m

NEU

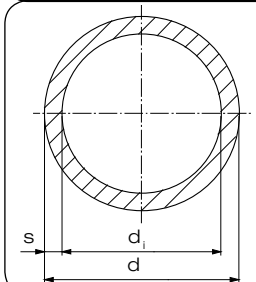
	d [mm]	s [mm]	di [mm]
	32	2,3	27,4
	50	2,3	45,4
	63	2,3	58,4
	90	2,3	85,4
	110	2,3	105,4

Artikelgruppe **PFA natur** 44 742...

L = 1 m		L = 5 m	
Art.-Nr.	kg/m	Art.-Nr.	kg/m
1032 00	0,61	0032 00	0,61
1050 00	0,98	0050 00	0,98
1063 00	1,25	0063 00	1,25
1090 00	1,80	0090 00	1,80
1110 00	2,21	0110 00	2,21

PFA Abdeckkappe / PFA Covering Cap

natur,

NEU

d [mm]
48

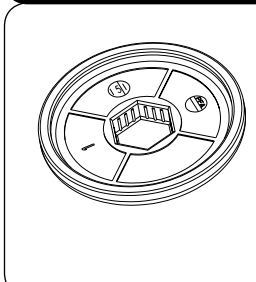

Artikelgruppe **PFA natur** 44 041...

Art.-Nr.	kg
7048 10	0,01

PFA HP Schweißdraht / PFA HP welding rod

Rolle 1 kg, natur

NEU

d [mm]
3,5
4

PFA HP

Art.-Nr.
4H 410...
1100 35
1100 40

FEP Platten GGS kaschiert gerollt / FEP GGS sheets rolled

natur, extrudiert, **Glasgestrick**, mit beidseitiger Schutzfolie

NEU

Artikelgruppe **FEP natur**

Rolle: 4F 681...

Dicke [mm]
1,5
2,3

10000 x 1250	
Art.-Nr.	kg/m ²
-	-
1125 23	5,91

15000 x 1250	
Art.-Nr.	kg/m ²
5125 15	4,36
-	-

FEP Rohre / FEP pipes

natur, extrudiert, L = 5 m

NEU

Artikelgruppe **FEP natur** 4F 725...

d [mm]	s [mm]	di [mm]
32	2,3	27,4
50	2,3	45,4
63	2,3	58,4
90	2,3	85,4
110	2,3	105,4
160	2,3	155,4

L = 5 m	
Art.-Nr.	kg/m
0032 00	0,51
0050 00	0,82
0063 00	1,05
0090 00	1,51
0110 00	1,86
0160 00	2,72

FEP Rohre GGS kaschiert / FEP pipes GGS fabric

natur, extrudiert, **Glasgestrick**, L = 5 m

NEU

Artikelgruppe **FEP natur** 4F 742...

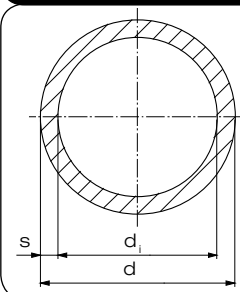
	d [mm]	s [mm]	di [mm]
	32	2,3	27,4
	50	2,3	45,4
	63	2,3	58,4
	90	2,3	85,4
	110	2,3	105,4
	160	2,3	155,4

L = 1 m	
Art.-Nr.	kg/m
1032 00	0,61
1050 00	0,98
1063 00	1,25
1090 00	1,80
1110 00	2,21
1160 00	3,23

L = 5 m	
Art.-Nr.	kg/m
0032 00	0,61
0050 00	0,98
0063 00	1,25
0090 00	1,80
0110 00	2,21
0160 00	3,23

FEP Schweißdraht / FEP welding rod

Rolle 1 kg, natur,

für Warmgas-Zihschweißung

NEU

d [mm]
3,5
4

FEP
Art.-Nr.
4F 410 ...
1100 35
1100 40

Reinigungsdraht für Schweißextruder / Purgung rod for welding extruder

Spule mit 2 kg

d [mm]
4

Sonderpolymer
Art.-Nr.
76 410 ...
0000 40

ABS-Filament für 3D Drucker

Filament für 3D Drucker,
Spule mit 1 kg,
Kreisquerschnitt

NEU

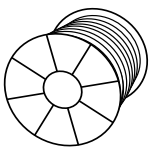
	d [mm]	Farbe
	1,75	natur
	1,75	blau
	1,75	weiss
	1,75	schwarz
	1,75	gelb
	1,75	rot
	1,75	grün

ABS

Art.-Nr.
9E 415

0000 17
5002 17
9010 17
9005 17
1023 17
3020 17
6026 17

PLA-Filament für 3D Drucker

Filament für 3D Drucker,
Spule mit 1 kg,
Kreisquerschnitt

NEU

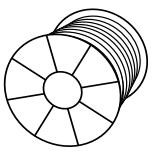
	d [mm]	Farbe
	1,75	natur
	1,75	blau
	1,75	weiss
	1,75	schwarz
	1,75	gelb
	1,75	rot
	1,75	grün

PLA

Art.-Nr.
9D 415

0000 17
5002 17
9003 17
9005 17
1018 17
3020 17
6026 17

Wickelrohre / Spiral pipes

Werkstoff: aus PE 100, PE 100-RC, PP-R, PP-H, PE-el, PP-el, PPs, PPs-el (coextrudiert)
 Wanddicken: von 5 mm bis max. 100 mm, größere Wanddicken nach Absprache

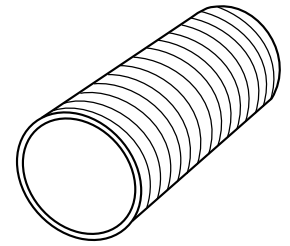

Durchmesser DN [mm]					
300	700	1200	1700	2500	3300
400	800	1300	1800	2600	3500
500	900	1400	2000	2700	3600
550	1000	1500	2300	2800	4000
600	1100	1600	2400	3000	

Anwendungsbeispiele

■ Lüftungsleitungen aus Wickelrohren



Lieferbar als profilierte Wickelrohre für hohe Unterdrücke oder als Vollwandrohre. Die Auslegung erfolgt in Anlehnung an die DIN 4741-1.

■ Wickelrohre für den Behälter- und den Apparatebau



Lieferbar mit durchgehender oder abgestufter Wanddicke gemäß Auslegung nach DVS 2205. Mindestwanddicke 10 mm.